

NZS 4514:2021

NEW ZEALAND STANDARD

# Interconnected smoke alarms for houses

Superseding NZS 4514:2009

NZS 4514:2021



## Single User PDF Terms & Conditions

You have material which is subject to strict conditions of use. Copyright in this material is owned by the New Zealand Standards Executive. Please read these terms and conditions carefully, as in addition to the usual range of civil remedies available to Standards New Zealand on behalf of the New Zealand Standards Executive for infringement of copyright, under New Zealand law every person who infringes copyright may be liable to a fine of up to \$10,000 for every infringing copy or imprisonment of up to 5 years, or a fine of up to \$150,000 or imprisonment not exceeding 5 years.

You have access to a single-user licence to read this non-revisable Adobe Acrobat PDF file and print out and retain ONE printed copy only.

We retain title and ownership of the copyright in this PDF file and the corresponding permitted printed copy at all times.

Under this license use of both the PDF file and the single permitted printed copy of this PDF file you may make are restricted to you. Under no circumstances are you permitted to save, sell, transfer, or copy this PDF file, the one permitted printed copy of this PDF file, or any part of either of them.

You undertake that you will not modify, adapt, translate, reverse engineer, decompile, disassemble or create derivative works based on any of the downloaded PDF file, nor will you merge it with any other software or document, even for internal use within your organization.

Under no circumstances may this PDF file be placed on a network of any sort without our express permission.

You are solely responsible for the selection of this PDF file and any advice or recommendation given by us about any aspect of this PDF file is intended for guidance only and is followed or acted upon entirely at your own risk.

We are not aware of any inherent risk of viruses in this PDF file at the time that it is accessed. We have exercised due diligence to ensure, so far as practicable, that this file does not contain such viruses.

No warranty of any form is given by us or by any party associated with us with regard to this PDF file, and you accept and acknowledge that we will not be liable in any way to you or any to other person in respect of any loss or damage however caused which may be suffered or incurred or which may arise directly or indirectly through any use of this PDF file.

Regardless of where you were when you received this PDF file you accept and acknowledge that to the fullest extent possible you submit to New Zealand law with regard to this licence and to your use of this PDF file.

Copyright Standards New  
Zealand

## NZS 4514:2021

### COMMITTEE REPRESENTATION

This standard was prepared by the P4512/14 Fire Alarms Committee. The membership of the committee was approved by the New Zealand Standards Approval Board and appointed by the New Zealand Standards Executive under the Standards and Accreditation Act 2015.

The committee consisted of representatives of the following nominating organisations:

Association of Building Compliance	Kāinga Ora   Homes and Communities (formerly Housing New Zealand and KiwiBuild)
Buildings Officials Institute of New Zealand	Institution of Fire Engineers (NZ Branch) (IFE)
Ministry of Business, Innovation & Employment (Building System Performance)	Local Government New Zealand   Te Kāhui Kaunihera ō Aotearoa
Kaupapa Mahi Turi – Deaf Action New Zealand	Te Manatū mō ngā Iwi ō te Moana-nui-ā-Kiwa   Ministry of Pacific Peoples
Engineering New Zealand	New Zealand Council of Elders
Fire and Emergency New Zealand (Operational)	New Zealand Fire Equipment Manufacturers' Association
Fire and Emergency New Zealand (Strategic)	Te Tari Mō Ngā Take Hauātanga   Office for Disability Issues
Fire Protection Association of New Zealand (Contractors' Special Interest Group)	Society of Fire Protection Engineers – New Zealand Chapter
Fire Protection Association of New Zealand (Advanced/ Innovative technologies)	The Retirement Villages Association of New Zealand
Fire Protection Association of New Zealand (Inspectorate Special Interest Group)	Te Pōkai Tara   Universities New Zealand
	Te Whare Wānanga o Waitaha   University of Canterbury

### ACKNOWLEDGEMENT

Standards New Zealand gratefully acknowledges the contribution of time and expertise from all those involved in developing this standard, and the three financial supporters: Fire and Emergency New Zealand; Fire Protection Charitable Trust; Ministry of Business, Innovation & Employment – Building System Performance.

### COPYRIGHT

This document is Crown copyright administered by the New Zealand Standards Executive. You may not reproduce any part of it without prior written permission of the New Zealand Standards Executive, unless your actions are permitted by the Copyright Act 1994.

We will vigorously defend the copyright in this standard. Your unauthorised use may result in a penalties being imposed under the Copyright Act 1994 including fines of up to \$10,000 for every infringing copy (up to a maximum of \$150,000 for the same transaction and for other specified offences) or imprisonment of up to 5 years. If the breach is serious, we may also seek additional damages from you as well as injunctive relief and/or an account of profits.

Published by Standards New Zealand, PO Box 1473, Wellington 6140.  
Telephone: (03) 943 4259, Website: [www.standards.govt.nz](http://www.standards.govt.nz).

### AMENDMENTS

No.	Date of issue	Description	Entered by, and date

New Zealand Standard

**Interconnected  
smoke alarms  
for houses**

**Superseding NZS 4514:2009**

Copyright Standards  
Zealand

## NOTES

Copyright Standards New  
Zealand

# CONTENTS

Committee representation .....	IFC
Acknowledgement .....	IFC
Copyright .....	IFC
Referenced documents .....	iv
Latest revisions .....	v
Review of standards .....	v
Outcome statement .....	v
Foreword .....	vi
<b>Section</b>	
1 GENERAL .....	1
1.1 Scope .....	1
1.2 Application .....	1
1.3 Interpretation .....	1
1.4 Definitions .....	1
1.5 Compliance with other regulations .....	2
1.6 Alternative technologies .....	2
2 INSTALLATION AND COMMISSIONING .....	3
2.1 Equipment .....	3
2.2 Location of smoke alarms .....	3
2.3 Alarm signals .....	7
2.4 Power supplies .....	8
2.5 Interconnection .....	8
2.6 Commissioning .....	10
3 MAINTENANCE .....	11
3.1 Smoke alarm maintenance .....	11
3.2 Checks and tests .....	11
3.3 End of life .....	11
<b>Appendix</b>	
A Installation guide (Informative) .....	12
B Installation examples (Informative) .....	16
<b>Table</b>	
1 Smoke alarm mounting location where there are exposed ceiling framing members .....	4
A1 Recommended alarm types for different locations .....	15
<b>Figure</b>	
2.1 Smoke alarm mounting locations .....	6
2.1 Smoke alarm mounting locations (continued) .....	7
2.2 Typical field wiring with interconnections .....	9
B1 Typical three-bedroom house .....	16
B2 Long house .....	17
B3 Multi-level house .....	18
B4 Multi-level house floor plans .....	19

## REFERENCED DOCUMENTS

Reference is made in this document to the following:

### New Zealand standards

NZS 4512:2021 Fire detection and alarm systems in buildings

### Joint Australian/New Zealand standards

AS/NZS 2201:---- Intruder alarm systems  
Part 1:2007 Client's premises – Design, installation, commissioning and maintenance

### International standards

ISO 12239:2010 Smoke alarms using scattered light, transmitted light or ionization

### Australian standards

AS 1603:---- Automatic fire detection and alarm systems  
Part 17:2011 Warning equipment for people with hearing impairment  
AS 3786:2014 Smoke alarms using scattered light, transmitted light or ionization

### British standards

BS EN 14604:2005 Smoke alarm devices  
BS 5446:---- Detection and alarm devices for dwellings  
Part 3:2015 Specification for fire alarm and carbon monoxide alarm systems for deaf and hard of hearing people

### Other standards

CAN/ULC S531:2014 (R2018) Standard for smoke alarms  
UL 217:2020 Standard for smoke alarms

### New Zealand legislation

Electricity (Safety) Regulations 2010  
Radiocommunications Regulations 2001



## LATEST REVISIONS

Referenced New Zealand and joint Australian/New Zealand standards can be found on [www.standards.govt.nz](http://www.standards.govt.nz). When using a standard referenced in this document, the user should refer to the exact version listed as subsequent revisions may introduce changes that are incompatible with this standard or other documents that invoke this standard.

## REVIEW OF STANDARDS

Suggestions for improvement of this standard will be welcomed. They should be sent to the National Manager, Standards New Zealand, PO Box 1473, Wellington 6140.

## OUTCOME STATEMENT

Application of this standard will help prevent loss of life and provide ongoing protection for the occupants of houses (single household units) by specifying requirements for the installation, commissioning, and maintenance of interconnected smoke alarms.

## FOREWORD

Fires in houses, flats, and apartments account for the majority of fire fatalities in buildings in New Zealand. Most of these preventable deaths occur while occupants are asleep or otherwise unable to either detect or respond to a fire condition in time. Properly installed and working smoke alarms provide early warning of a potentially life-threatening fire so that occupants have time to escape to safety.

This standard provides a specification for the selection, installation, commissioning, and maintenance of interconnected smoke alarms in houses (single household units).

This edition is a partial technical revision and supersedes NZS 4514:2009. Allowance has been made for long-life batteries and wirelessly interconnected smoke alarms. Changes have been made for ceilings with exposed framing members. Testing requirements have been simplified. The appendices have been edited and updated to provide more clarity and guidance on the selection and location of smoke alarms.

It should be noted that this standard does not apply to 'Type 5' smoke alarms, which are covered in NZS 4512.

New Zealand Standard

# Interconnected smoke alarms for houses

## 1 GENERAL

### 1.1 Scope

This standard sets out the requirements for the installation, maintenance, and commissioning of interconnected smoke alarms. It also provides information on the selection of these types of smoke alarms.

### 1.2 Application

This standard applies to interconnected smoke alarms installed in household units.

### 1.3 Interpretation

For the purpose of this standard, the word 'shall' refers to requirements that are essential for compliance with the standard, while the word 'should' refers to practices that are advised or recommended.

The term 'informative' has been used in this standard to define the application of the appendix to which it applies. An 'informative' appendix gives additional information and is only for guidance. It does not contain requirements.

### 1.4 Definitions

For the purposes of this standard the following definitions shall apply:

<b>Household unit</b>	<ul style="list-style-type: none"> <li>(a) A building or group of buildings, or part of a building or group of buildings, that is:               <ul style="list-style-type: none"> <li>(i) Used, or intended to be used, only or mainly for residential purposes; and</li> <li>(ii) Occupied, or intended to be occupied, exclusively as the home or residence</li> <li>(iii) Of not more than one household; but</li> </ul> </li> <li>(b) This does not include a hostel, boarding house, or other specialised accommodation</li> </ul>
<b>Heat alarm</b>	An integral device containing both a heat detector and an alarm-sounding device
<b>Smoke alarm</b>	An integral device containing both a smoke detector and an alarm-sounding device

## 1.5 Compliance with other regulations

The smoke alarm installation shall comply with all applicable electrical safety and radio communication requirements.

## 1.6 Alternative technologies

This standard specifies requirements for interconnected smoke alarms for houses. Alternative technologies that do not comply with the specific requirements but give equivalent performance are not necessarily prohibited. In such cases, laboratory appraisal testing will need to demonstrate this equivalence.

Copyright Standards New Zealand

## 2 INSTALLATION AND COMMISSIONING

### 2.1 Equipment

#### 2.1.1 Compliance standards

Smoke alarms shall comply with at least one of the following:

- (a) UL 217;
- (b) CAN/ULC S531;
- (c) BS EN 14604;
- (d) ISO 12239; or
- (e) AS 3786

#### 2.1.2 Hush-button facilities

Smoke alarms shall be provided with a 'hush button' to temporarily silence audible alarm signals in the event of nuisance activation. The hush button shall be located either on the smoke alarm itself or at another readily accessible location (for example, a hallway).

### 2.2 Location of smoke alarms

#### 2.2.1 General

The location of smoke alarms shall be as follows:

- (a) Smoke alarms shall be located on or near the ceiling;
- (b) Smoke alarms shall be located in all bedrooms, living spaces, hallways, and landings within the building;
- (c) Where a kitchen is separated from the living spaces and hallways by doors that can be closed, an alarm specified by its manufacturer as suitable for a kitchen shall be located in the kitchen. This may be a heat alarm to avoid nuisance activations;
- (d) In a multi-level household unit, there shall be at least one smoke alarm on each level; and
- (e) Where more than one smoke alarm is needed to meet the requirements of this standard, these smoke alarms shall all be interconnected so that when one activates, all smoke alarm devices in the household unit will sound.

NOTE – For additional information on selection and location of alarms, see Appendices A and B.

#### 2.2.2 Spacing

In locations where they are required, smoke alarms shall be spaced as follows:

- (a) The distance from any wall to a smoke alarm shall not exceed 5 m; and
- (b) Smoke alarms shall be within 10 m of each other in any direction.

**2.2.3 Ceilings**

Smoke alarms shall be located as follows:

- (a) In rooms with flat ceilings, or with ceiling slopes less than 1 in 10: at least 200 mm from the wall. See Figure 2.1(a);
- (b) In rooms with ceiling slopes greater than 1 in 10: on the high side of the ceiling, between 200 mm and 500 mm from the apex. See Figure 2.1(b);
- (c) In rooms where a ceiling mount is not possible: between 100 mm and 300 mm from the ceiling. See Figure 2.1(c).

**2.2.4 Mounting**

Smoke alarms shall be mounted in accordance with the manufacturer’s instructions using any brackets and mounts supplied.

**2.2.5 Exposed framing members**

Where there are exposed framing members on the ceiling such as a beam, rafter, purlin, or joist, the requirements in Table 1 shall be applied.

Where smoke alarms are mounted on the ceiling, they shall be mounted at least 200 mm away from an exposed framing member.

See also Figure 2.1(d) and (e).

**Table 1 – Smoke alarm mounting location where there are exposed ceiling framing members**

Depth of exposed framing member	Spacing between exposed framing members		
	Up to 900 mm	Between 900 mm and 2400 mm	More than 2400 mm
<b>Up to 100 mm</b>	Alarm mounted either on underside of exposed framing member or on ceiling	Alarm mounted either on underside of exposed framing member or on ceiling	Alarm mounted either on underside of exposed framing member or on ceiling
<b>Between 100 mm and 300 mm</b>	Alarm mounted on underside of exposed framing member	Alarm mounted either on underside of exposed framing member or on ceiling	Alarm mounted on ceiling on at least one side of exposed framing member
<b>Between 300 mm and 460 mm</b>	Alarm mounted on underside of exposed framing member	Alarm mounted on ceiling on at least one side of exposed framing member	Alarm mounted on ceiling on at least one side of exposed framing member
<b>More than 460 mm</b>	Alarm mounted on underside of exposed framing member	Alarm mounted on ceiling on both sides of exposed framing member	Alarm mounted on ceiling on both sides of exposed framing member

### 2.2.6 Locations to avoid

Smoke alarms should not be located:

- (a) In dead air spaces as shown in Figure 2.1;
- (b) Within 300 mm of a light fitting;
- (c) Closer than 400 mm to any air-supply opening;
- (d) Closer than 400 mm outside the circumference of the blades of a ceiling fan;
- (e) In attics, roof spaces, or other places where extremes of temperature, dust, and high airflows may occur;
- (f) Near a decorative object, door, light fitting, or window moulding that may prevent smoke from entering the sensing chamber;
- (g) On surfaces that are normally warmer or colder than the rest of the room, such as a poorly insulated ceiling below an unfinished attic or an uninsulated exterior wall;
- (h) Closer than 400 mm to the supply air opening of an air-conditioning unit or forced air ventilation unit;
- (i) In, next to, or directly above heaters or air-conditioning vents, opening windows, or wall vents that can change the direction of airflow;
- (j) In dusty or dirty environments;
- (k) Within 1 m from a cooktop, and where possible at least 3 m clearance from a cooktop should be maintained.

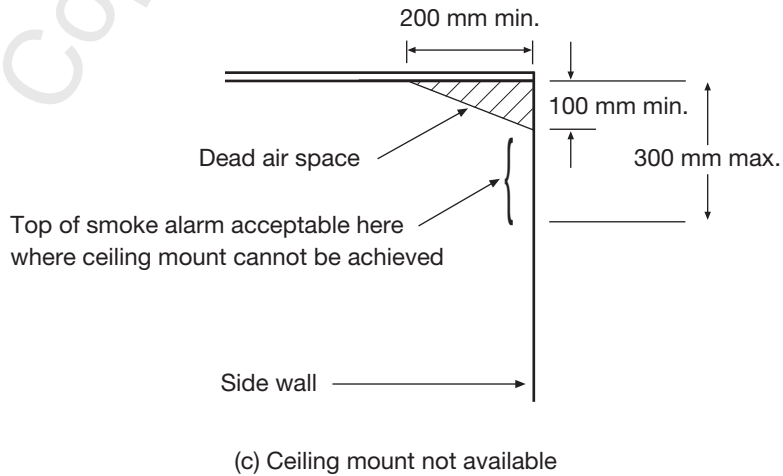
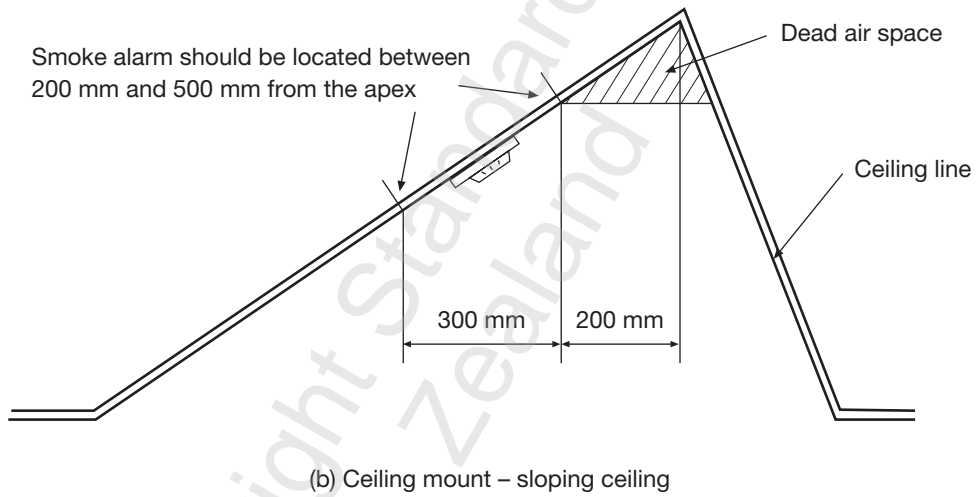
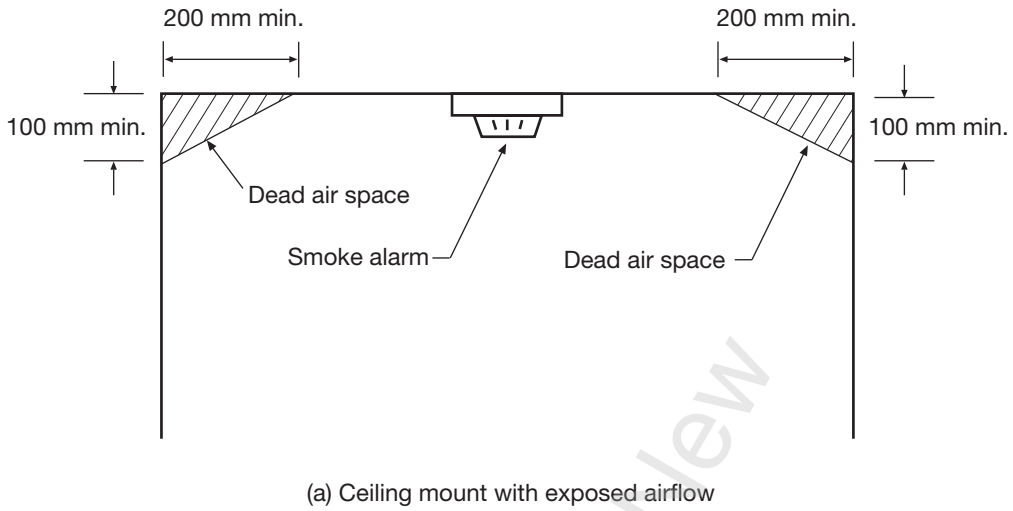
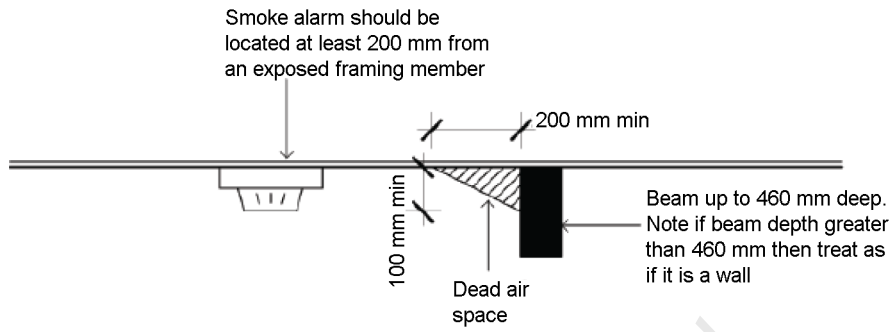
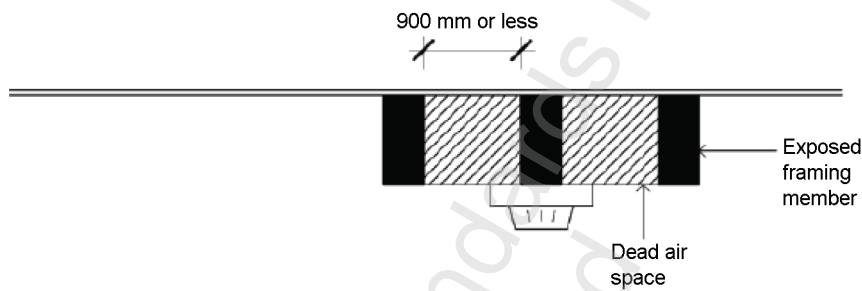

Figure 2.1 – Smoke alarm mounting locations





(d) Exposed framing members such as beams, rafters, joints, purlins



(e) Exposed framing members

Figure 2.1 – Smoke alarm mounting locations (continued)

## 2.3 Alarm signals

### 2.3.1 Audible alarm signals

Smoke alarms shall be installed so that the audible signal has a sound pressure level of not less than 75 dB(A), and not more than 110 dB(A) in all bedrooms, living spaces, hallways, and landings in the household unit. The sound pressure level shall be measured at any normally accessible point at a height of 1.8 m.

### 2.3.2 Additional sensory alarm signals

Where audible alarm signals are not adequate to awaken a sleeping occupant, additional types of sensory stimulating alarm devices may be used, such as visual or vibrating alerting devices. AS 1603.17 and BS 5446.3 contain requirements for such devices.

## 2.4 Power supplies

### 2.4.1 Power sources

Smoke alarms shall be powered from one of the following sources:

- (a) A permanently energised 230 VAC mains power supply fed from the permanently energised (unswitched) side of a commonly used circuit (for example, lighting), or an external DC power supply continuously maintained from a 230 VAC mains supply. A standby power supply shall be included to power the smoke alarm during periods of mains power failure. Where the standby power supply is contained within the smoke alarm and is user-serviceable, the battery shall be of a type nominated by the smoke alarm manufacturer. Where the standby supply cannot be serviced (for example, a non-removable battery), it shall be rechargeable;
- (b) An external DC power supply continuously maintained from a 230 VAC mains supply, with battery backup, where the battery is external to the smoke alarm. This power supply and battery backup shall comply with either NZS 4512 or AS/NZS 2201.1. All wiring between the power supply and the smoke alarms shall be supervised such that an open or short circuit generates a fault condition or an alarm condition;
- (c) A long-life (minimum 10 years), non-removable, sealed battery.

### 2.4.2 Field wiring

Field wiring for smoke alarms shall be not less than 1.0 mm<sup>2</sup> cable for 230 VAC mains powered detectors and not less than 0.5 mm<sup>2</sup> stranded cable for extra-low voltage (less than 32 VAC or 50 VDC) powered detectors.

### 2.4.3 Faults

Any fault condition shall generate an audible warning within the household unit.

Where a system is remotely monitored, faults should also be signalled to the remote monitoring centre.

## 2.5 Interconnection

### 2.5.1 More than one smoke alarm

Where more than one smoke alarm is installed within a household unit, all smoke and heat alarms within the household unit shall be interconnected to provide a common alarm from all units when any one smoke or heat alarm is activated.

### 2.5.2 Manufacturer's instructions

Smoke alarms shall be interconnected in accordance with the manufacturer's instructions. All devices, including heat alarms, intended to be connected to a smoke alarm circuit shall be compatible with the smoke alarms.

**2.5.3 Number of interconnected smoke alarms**

The number of interconnected alarms on one system shall not exceed the number specified in the manufacturer’s instructions.

**2.5.4 Wired or wireless**

The interconnection between alarms may be wired or wireless.

See Figure 2.2 for typical wired interconnection.

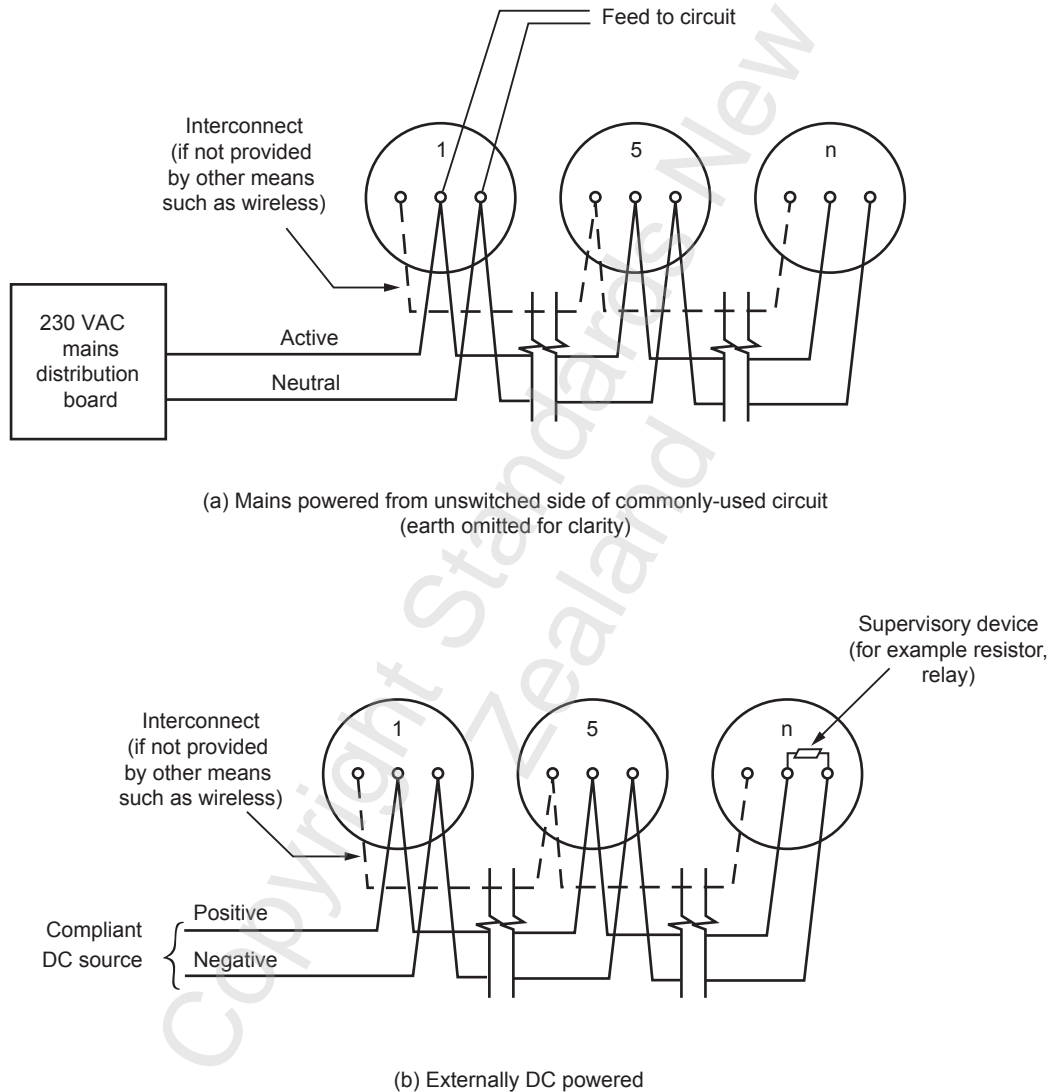

**Figure 2.2 – Typical field wiring with interconnections**

**2.5.5 Security systems**

Low-voltage hard-wired smoke and heat alarms may be incorporated into a security system, provided the requirements of this standard are met.

## 2.6 Commissioning

Where smoke alarms have a power supply of 230 VAC or over 120 VDC, they shall be installed in accordance with the Electrical (Safety) Regulations and shall be tested and certified by a licensed electrical worker.

All systems shall be tested and, where required, certified as follows:

- (a) Smoke alarms are located in all areas specified in 2.2;
- (b) No smoke alarm or other device has been installed in an unsuitable location;
- (c) The system is installed as per the manufacturer's instructions;
- (d) The hush facility for each smoke alarm operates correctly;
- (e) The interconnection of all devices operates correctly;
- (f) All ancillary devices operate in the alarm condition, and their operation does not adversely affect the functioning of the smoke alarms;
- (g) The sound pressure level in all required areas (see 2.3.1) is no less than 75 dB(A), and no more than 110 dB(A), measured at any normally accessible point at a height of 1.8 m;
- (h) Where mains power is used, that it has been derived from a permanently energised circuit;
- (i) No faults are present;
- (j) All devices on the system are compatible;
- (k) Manufacturer's instructions for all smoke alarms and ancillary devices are available (as applicable).

## 3 MAINTENANCE

### 3.1 Smoke alarm maintenance

Smoke alarms require regular maintenance to ensure their successful operation in the event of a fire.

Smoke alarms shall be maintained by the householder in accordance with manufacturer's instructions.

NOTE – See Appendix A for information on solving or preventing common problems.

### 3.2 Checks and tests

#### 3.2.1 Monthly

Each smoke alarm should be tested at least once a month by activating the 'test' function. The tested smoke alarm and all the smoke and heat alarms interconnected with it should sound.

#### 3.2.2 Six-monthly

Each smoke alarm should be inspected and cleaned every six months using the soft brush attachment of a household vacuum cleaner to remove any dust, cobwebs, insects, or the like.

NOTE –

- (1) Liquid cleaners or solvents should not be used because they will damage the unit and may present an electric shock hazard.
- (2) The unit should not be disassembled as this will damage the unit and may present an electric shock hazard.

### 3.3 End of life

A smoke alarm with a long-life, non-removable, sealed battery shall be replaced by the manufacturer's specified replacement date, or when the unit indicates a low battery condition, whichever comes first.

All other smoke alarms shall be replaced after ten years from the date of manufacture, unless the manufacturer's instructions specify otherwise.

## APPENDIX A – INSTALLATION GUIDE

(Informative)

### A1 General

Fires release heat, toxic gases, and airborne particles. The inhalation of toxic smoke is the most common cause of death in house fires.

A fire can spread rapidly, fuelled by the surrounding combustible material and the heat produced by the fire. The rate of fire spread will depend on the flammability of the home's contents, construction materials and their surfaces, and the oxygen supply.

Fire and smoke may overcome occupants within minutes. The sooner a fire is detected, the more time is available for escape.

The nature of fires will vary depending on the item(s) ignited and the conditions. Following ignition, a fire may break out in flames or smoulder for several hours. Some sensing methods are more appropriate than others for specific types of fires.

### A2 Location and number of smoke alarms

#### A2.1 General

There should be a smoke alarm in each room of a house, especially bedrooms. Most fatal fires occur because sleeping occupants were not awakened in time to escape.

#### A2.2 Locations to avoid

To avoid nuisance alarms, the location of smoke alarms in the following areas should be avoided:

- (a) Near a stove, space heater, water heater, burner, furnace, or other fuel-burning or heat-producing source;
- (b) In the air stream from a kitchen where cooking smoke can be carried into the smoke alarm;
- (c) In very damp, humid, or steamy areas, or near showers, saunas, dishwashers, and so on;
- (d) Where extremes of temperature can be expected – particularly unheated rooms, outdoor areas, and on uninsulated outside walls;
- (e) In very dusty, dirty, or greasy areas;
- (f) In draughty areas where smoke can be blown away from the smoke alarm preventing reliable operation;
- (g) Near an insect-infested area;
- (h) Near fluorescent lights, as these can interfere with correct operation.

See Table A1 for the recommended alarm types for the various locations in the home.

If the replacement or relocation of an externally powered smoke alarm is necessary, the work might need to be tested and certified by a licensed electrical worker.

### **A3 Interconnection**

Closed doors can act as a heat and smoke barrier, slowing the spread of fire. Interconnection of all smoke alarms ensures the alarm is heard on either side of the closed door.

Smoke alarms located remotely from the bedroom areas might not be loud enough to waken the average person. The interconnection of smoke alarms provides a simultaneous alarm throughout the house thereby providing earlier warning for all areas in the house.

When replacing an interconnected smoke alarm, the replacement should be a compatible model from the same manufacturer.

### **A4 Airflow**

A smoke alarm will detect a fire when the smoke or particulate matter at the device reaches the alarm threshold level. If the air is moving, such as with forced air ventilation systems, fans, or a breeze through open doors and windows, these combustion products may not reach a smoke alarm until after the fire has become much larger. This will leave less time for escape.

### **A5 Dead air spaces**

Smoke and heat generated by a fire generally rise, spread out, and begin to bank down from the ceiling. However, smoke may be unable to penetrate the air space in the corner where the ceiling and wall meet. In most fires, this dead space measures approximately 0.2 m across the ceiling and 0.1 m down the wall from the corner. A dead air space will also be found at the apex of a sloping ceiling. Dead air spaces may also be found between joists, purlins, and beams. See Figure 2.1.

Dead air spaces are unsuitable locations for smoke alarms. While the preferred location of smoke alarms is on the ceiling, in some instances it may be necessary to mount them on a wall to avoid dead air spaces.

### **A6 Occupants with special needs**

Where the occupant may not hear an alarm due to being deaf or hard of hearing, visual and vibrating devices should be considered.

Alarms with a 520 Hz square wave sound character may be more effective at waking a wider range of people, including the elderly and the hard of hearing.

Where an occupant such as an elderly or sick person, or a very young child, cannot self-evacuate, a home evacuation plan should reflect this.

## A7 Types of alarms

### A7.1 General

The most common smoke alarm types are photoelectric and ionisation. When deciding which type to install, the most likely type of fire (smouldering or flaming) should be considered for each location to enable early detection as well as reduce the likelihood of nuisance alarms. Both types respond by detecting the airborne particulate matter from the fire. Heat alarms react to the build-up of temperature from a fire.

### A7.2 Photoelectric smoke alarms

Photoelectric smoke alarms sense visible smoke particles. They are particularly responsive to smouldering fires and the dense smoke given off by foam-filled furnishings or overheated PVC wiring. Photoelectric smoke alarms are generally less prone to nuisance alarms from cooking but may be more prone to nuisance alarms caused by steam, dust, or insect contamination. It is important to clean photoelectric smoke alarms regularly with the soft brush attachment of a vacuum cleaner.

### A7.3 Multi-sensor (or multi-criteria) smoke alarms

Multi-sensor smoke alarms incorporate two (or more) detection technologies. These alarms typically have both ionisation and photoelectric sensors, or a heat and photoelectric sensor. Multi-sensor smoke alarms offer a broader response to both flaming and smouldering fires than one technology alone. Most multi-sensor alarms operate on an algorithm, where a combination of input factors needs to be met before the alarm sounds. These alarms can reduce the likelihood of nuisance alarms in some difficult areas. The alarm will still sound if only one sensor detects a fire, however a stronger signal is typically required. Multi-sensor alarms are sometimes called multi-criteria alarms.

In this context, smoke alarms that are paired with only a carbon monoxide sensor are not considered multi-sensor smoke alarms as the carbon monoxide detection is to warn against carbon monoxide poisoning, not smoke or fire.

### A7.4 Heat alarms and heat detectors

Heat alarms provide an additional method of fire detection in locations where detection is considered advisable, yet the installation of a smoke alarm would cause an unacceptable level of nuisance alarms. Examples may include enclosed laundries or kitchens, or a garage.

Heat alarms are not a substitute for smoke alarms as they are not sensitive to smoke. A heat alarm should be interconnected to any smoke alarms so that the alarm can be heard throughout the building. Heat alarms or detectors require the least maintenance of any alarm and are less affected by contamination.

### A7.5 Ionisation smoke alarms

Ionisation smoke alarms respond to a wide range of fires. They are particularly responsive to flaming fires where there is little visible smoke. They are generally less troubled by dust or insect contamination, but more prone to nuisance alarms due to fumes from cooking. Ionisation smoke alarms are marginally slower to respond to slow smouldering fires than photoelectric types.



**Table A1 – Recommended alarm types for different locations**

<b>Mandatory smoke alarm locations</b>	<b>Photoelectric smoke alarm</b>	<b>Multi-sensor/ multi-criteria smoke alarm</b>	<b>Heat alarm</b>	<b>Ionisation smoke alarm</b>
Bedrooms/sleeping areas	Better	Best	Does not conform	Not recommended
Common area separating bedroom(s) and rest of house	Better	Best	Does not conform	Not recommended
Landings in multi-level house	Better	Best	Does not conform	Not recommended
Living room	Better	Best	Does not conform	Good
Family room	Better	Best	Does not conform	Good
In any of above if near kitchen	Good	Not recommended <sup>a</sup>	Does not conform	Not recommended
Kitchen separated by doors	Better (provided alarm is rated for use in a kitchen)	Best (provided alarm is rated for use in a kitchen)	Good	Not recommended
<b>Optional (additional) locations for alarms<sup>a</sup></b>	<b>Photoelectric smoke alarm</b>	<b>Multi-sensor/ multi-criteria smoke alarm</b>	<b>Heat alarm</b>	<b>Ionisation smoke alarm</b>
Bathrooms, laundries	Not recommended	Not recommended <sup>a</sup>	Best	Not recommended
Kitchens (non-separated)	Good <sup>a</sup>	Not recommended <sup>a</sup>	Best	Not recommended
Attached garage	Not recommended	Not recommended <sup>a</sup>	Best	Not recommended
<sup>a</sup> As these applications have a higher risk of nuisance alarms, locate the smoke alarm as far away from cooking as possible. Multi sensor and multi criteria smoke alarms come in a wide variety of different configurations and combination of detection methods. Although the table does not recommend placing smoke detection in these locations, there may be multi-sensor alarms available that are suitable for these applications. Read the manufacturer's recommendations.				
NOTE – The term 'good' signifies the minimum level of suitability. 'Better' and 'best' are improvements on this. 'Not recommended' signifies an unsuitable choice for a particular location. 'Does not conform' signifies that the detector selection for the location is not compliant with the requirements in this standard.				

## **A8 Nuisance alarms**

A nuisance alarm occurs when a smoke alarm is triggered by a non-hazardous source such as everyday cooking smoke or a steamy shower. If nuisance alarms are experienced, try one or more of the following:

- (a) Choose a better alarm type (see Table A1);
- (b) Relocate the smoke alarm away from any source of steam, cooking fumes, and so on;
- (c) Improve ventilation of the area to remove the cause of the nuisance alarm;
- (d) Close doors that allow the spread of unwanted airborne particles;
- (e) Replace the smoke alarm if contaminated or dirty and unable to be cleaned as required by 3.2.2, or older than ten years.

Do not spray deodorant or fly spray at a smoke alarm as this may contaminate or activate the alarm.

## APPENDIX B - INSTALLATION EXAMPLES

(Informative)

As a guide, some examples are provided below for different house layouts. Always ensure you comply with the requirements in this standard.

### Example B1 Three-bedroom house

Figure B1 shows a design for a typical house. Smoke alarms are installed in each bedroom, the family room, and in the living/dining room and hallway associated with bedrooms 2 and 3. Warning is provided if smoke accumulates in the escape paths associated with both bedroom areas, or within each bedroom. An important consideration for this house is the choice of a photoelectric smoke alarm in the family room. A photoelectric alarm was installed in the family room near the kitchen because it is less sensitive to cooking fumes. (See Appendix A for further clarification of smoke alarm types.) The six alarms are interconnected to enable a general alarm to be given throughout the house.

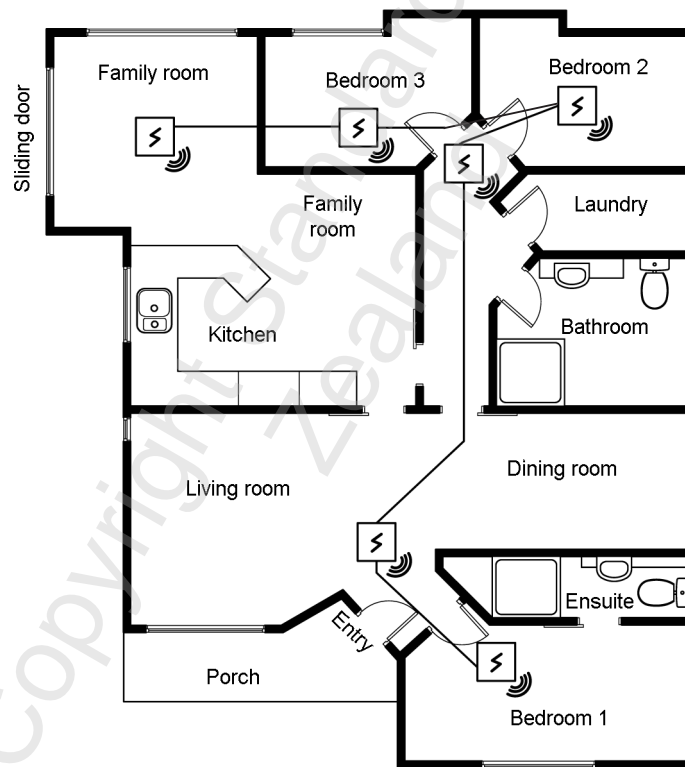

Figure B1 – Typical three-bedroom house

### Example B2 Long house

In a house with a long layout (see Figure B2), one smoke alarm is located in each bedroom, with one smoke alarm in the hallway adjacent to the bedroom area protecting the escape path either through the family room or the laundry. Additional smoke alarms are located in the family and lounge/dining areas. The hallway door potentially divides the house into two areas, 'sleeping area' and 'living area'. Should this door be closed, products of combustion originating from the living area will be delayed in reaching the

smoke alarm in the hallway, thereby preventing early warning. Closing the door at night will help restrict smoke and fire spread; however, this makes it necessary to place a smoke alarm (photoelectric because it is less sensitive to cooking fumes) in the family area. For the same reason, it is necessary to place a smoke alarm in the lounge/dining area, where otherwise a significant fire could develop undetected and prevent escape through the main entry.

As it can also be separated from the remainder of the house by closing the doors, an alarm is installed in the kitchen as well. To avoid nuisance alarms, because it is within 3 m of the cooktop, a heat alarm is installed instead of a smoke alarm.

The interconnected smoke alarms ensure that any alarm will be simultaneously raised in both the sleeping and living areas.

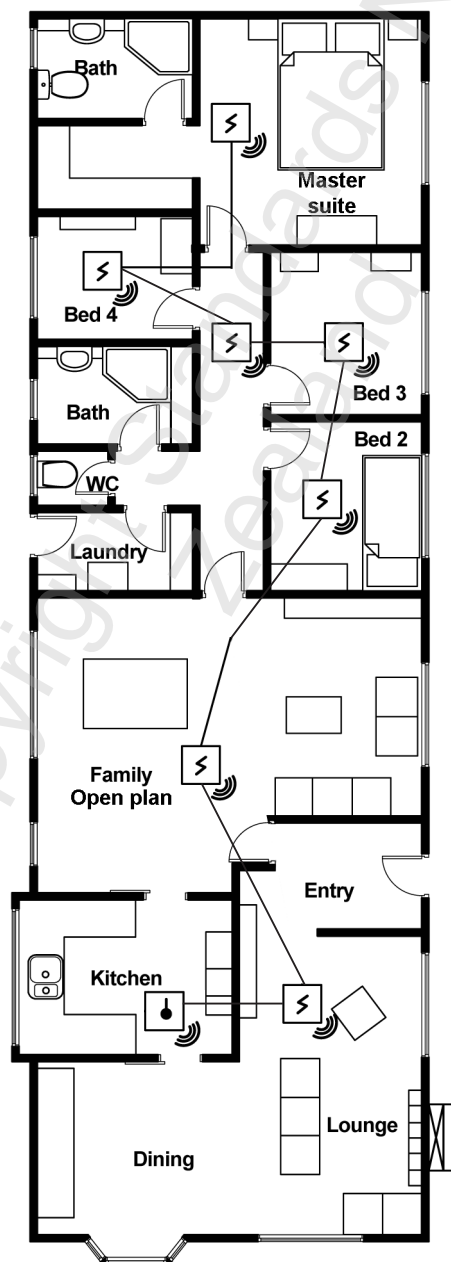

Figure B2 – Long house

### Example B3 Multi-level house

In a multi-level house (see Figure B3), a smoke alarm is required to be fitted on each level. Most houses of this type have only one escape path from the upper level, through the lower level.

Sleeping occupants on the upper level need to be quickly alerted to an alarm originating from elsewhere in the house as the escape path may rapidly become untenable. To ensure all occupants are alerted, all smoke alarms are required to be interconnected.

A smoke alarm has been positioned in each bedroom and in the primary escape path for each level (gallery and lounge/dining). A smoke alarm is also required in the family room where an undetected fire could grow significantly and compromise the only escape from the upper level through the lounge/dining area.

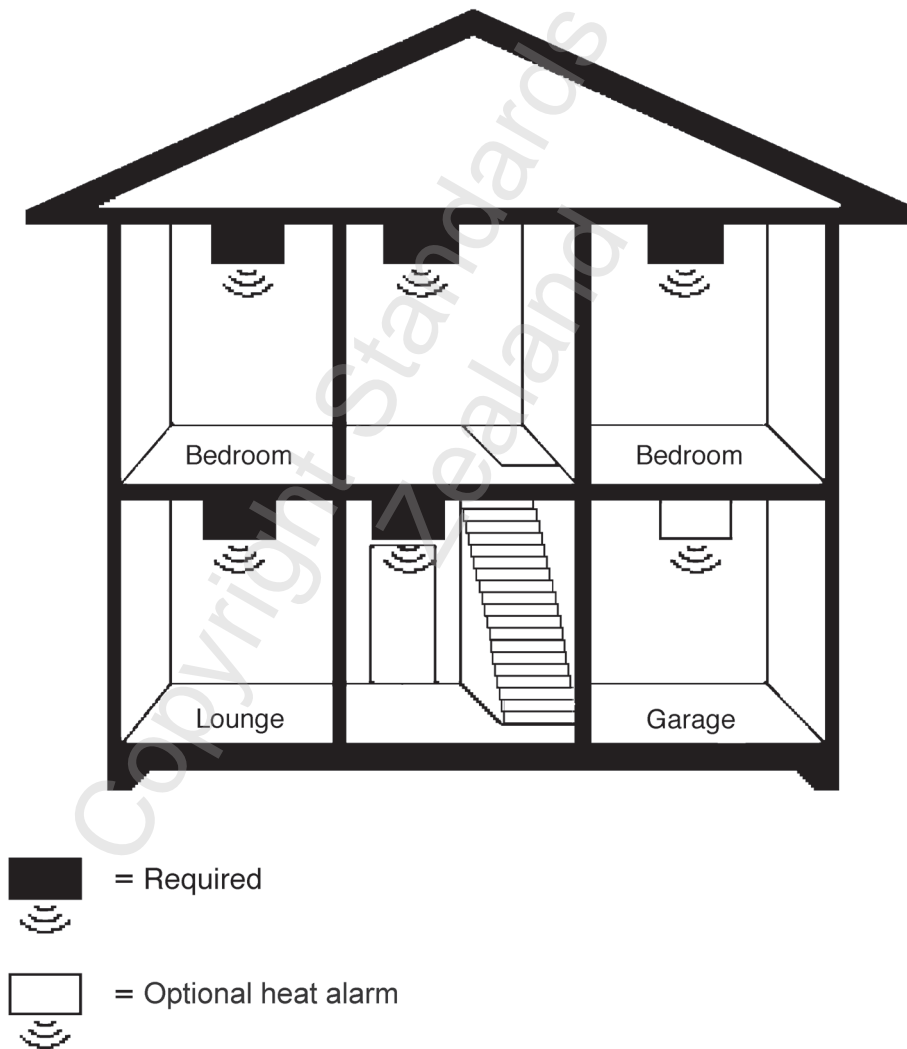

Figure B3 – Multi-level house

Protection can be enhanced (see Figure B4) by:

- (a) Choosing a photoelectric (because it is less sensitive to cooking fumes) smoke alarm in the family room. The closure of the access door into the lounge at night segregates the family/kitchen area as a separate fire zone;
- (b) Placing an interconnected heat alarm in the garage. Even though the garage is integral to the house, a fire starting in the garage will not be detected by the smoke alarms installed inside the house. Theoretically a smoke alarm could be used, but is likely to generate an unacceptable level of nuisance alarms from dust or vehicle exhaust fumes. A heat alarm is less sensitive to these conditions. The heat alarm needs to be interconnected to the smoke alarms for early warning.

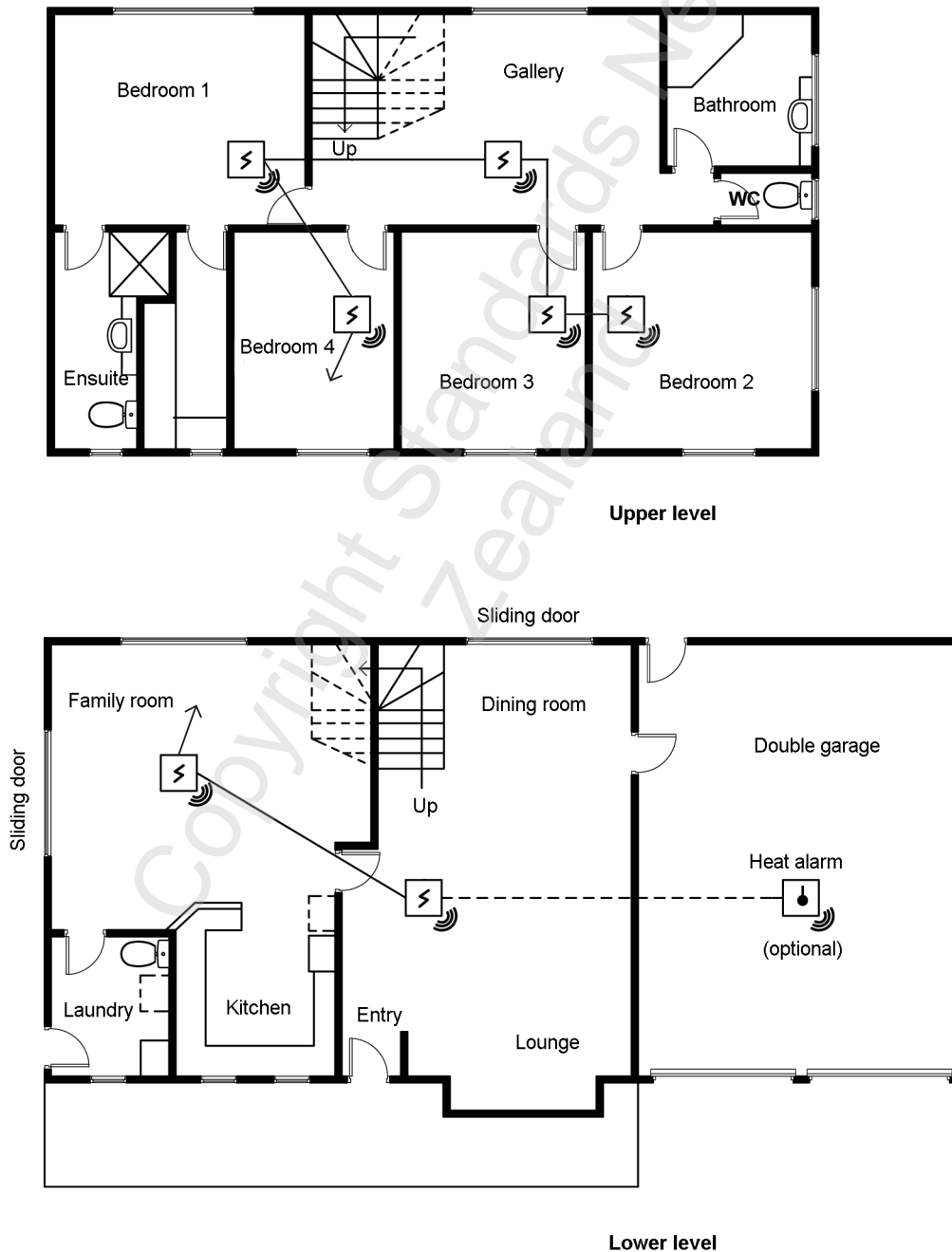

Figure B4 – Multi-level house floor plans

## NOTES

Copyright Standards New  
Zealand

Copyright Standards New Zealand

---

**© 2021 CROWN COPYRIGHT ADMINISTERED BY THE NEW ZEALAND STANDARDS EXECUTIVE**

Approved by the New Zealand Standards Approval Board on 7 April 2021 to be a New Zealand Standard pursuant to section 12 of the Standards and Accreditation Act 2015.

First published: 30 April 2021

The following references relate to this standard:

Project No. P4512/14

Draft for comment No. DZ 4514

Typeset by: Standards New Zealand

---



**MINISTRY OF BUSINESS,  
INNOVATION & EMPLOYMENT**  
HĪKINA WHAKATUTUKI

New Zealand Government