

FILETTO M25x1.5

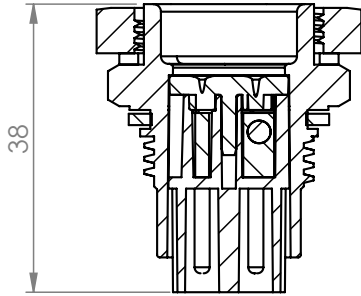

SEZIONE A-A

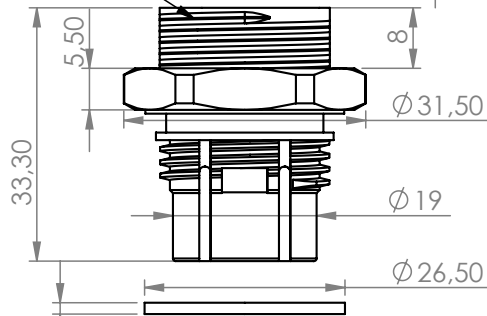
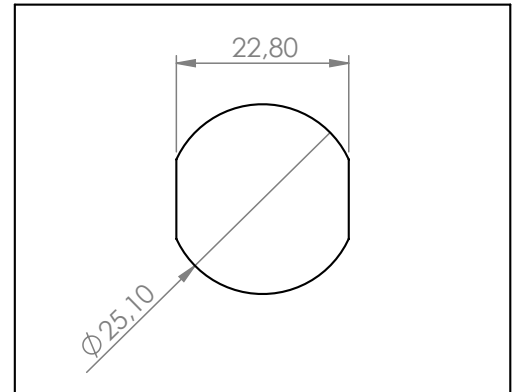
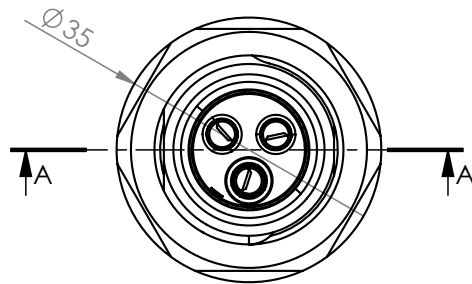
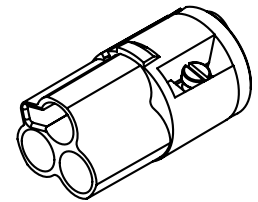
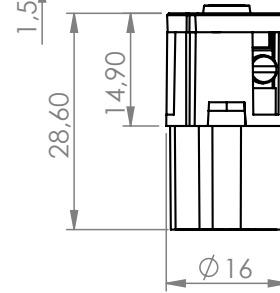

SEDE TH385 M25



Via Bancora e Rimoldi, 27
22070 Guanzate (CO)

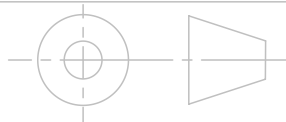

SCALA
SCALE
1:1

FORMATO
FORMAT

N°REVIS.
REVIS.N°

VALIDO DA:
VALID FROM:

Questo disegno è di proprietà della Techno srl, senza autorizzazione scritta della stessa non potrà essere utilizzato per la costruzione del pezzo rappresentato né venir comunicato a terzi o riprodotto. La società proprietaria tutela i propri diritti a rigore di legge.

This drawing is the exclusive propriety of TECHNO Srl. This document without written consent cannot be reproduced or shown to third parties or used elsewhere. All rights are reserved also in the case of a patent or registered design being granted.

DISEGN.
DRAWN

DATA-DATE
06-09-2013

NOME-NAME

GABRIELE FLORES

APPROV.
APPROVED

CODICE
CODE

DESCRIZIONE-DESCRIPTION

THB.385.A1A

N°DISEGNO
DRAW N°

MATERIALE
MATERIAL

PATH-PERCORSO

FILE

THB.385.A1A

VARIAZIONI
ALTERATIONS

DATA
DATE

COORDINATE
COORDINATES

MOTIVO DELLA REVISIONE-CAUSE OF MODIFICATION

RIFER.
IND.